

Article number: 2314451417

Description: E+G Cast iron wheel 451417  
RE.F4-300-RSL - loose wheel with ball bearings

## Measures

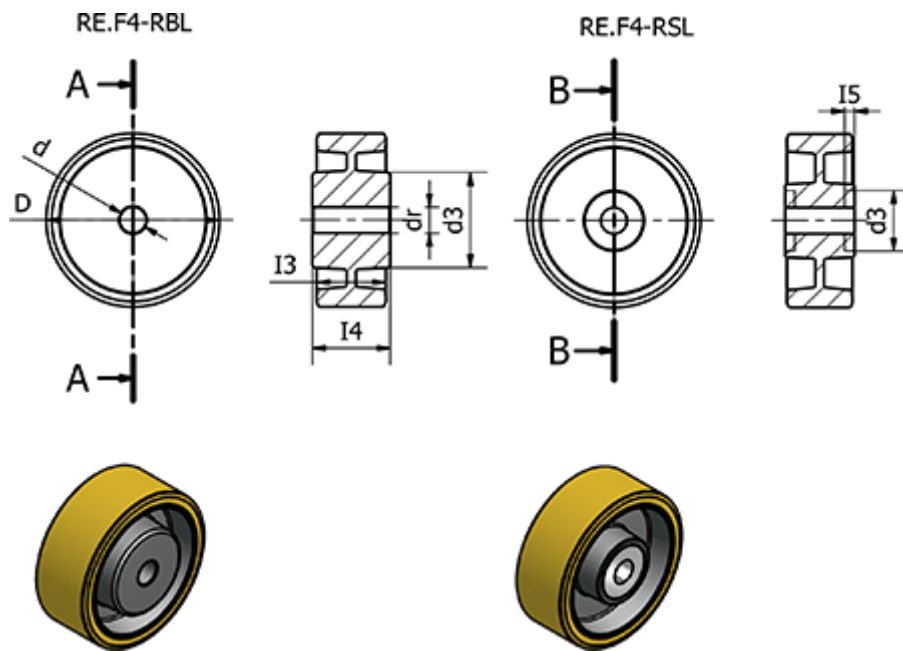

Code	= 451417	Max static load (N)	= 34000
d	= 300	Rolling resistance (N)	= 6000
d3	= 62	Type	= RE.F4-300-RSL
dr	= -	Weight (g)	= 13800
Dynamic carrying capacity (N)	= 23000		
I3	= 80		
I4	= 86		
I5	= 17		